

Cryogenic 1/4" Combination Pressure Builder/Economizer CBH502 & CBC502 Series

Application

The regulator combines the function of Pressure Building and Economizer functions in one compact unit. Available in Chart and Taylor-Wharton piping geometries and a variety of pressure ratings.

Features

- All parts are copper alloy (brass), PTFE and stainless steel materials selected specifically for compatibility with cryogenic temperatures down to -320° F. (-196°C)
- PTFE seat helps assure a positive shut-off at cryogenic temperatures down to -320° F. (-196°C)
- High and low pressure builder/economizers are the same compact size designed to fit in close quarters.
- Interchangeable with existing cryogenic regulator units.
- Inlet screen helps prevent foreign material from entering the regulator.
- Locknut is provided to maintain adjusting screw setting.
- Maximum inlet pressure of 550 psig (37.9 barg)
- Cleaned for oxygen service per CGA G-4.1
- 100% Factory Tested.
- Suitable for argon, CO2, nitrogen, oxygen and LNG.



CBH502 Series

Materials

Body	Brass
Bonnet	Brass
Seat Disk	PTFE
Springs	Stainless Steel
Gaskets	PTFE & Copper
Diaphragm	Bronze

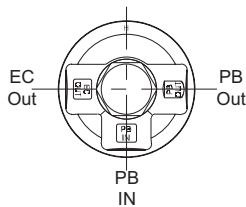

CBH Series

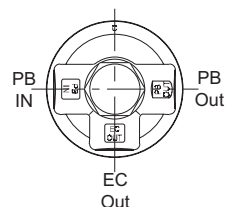

CBC Series

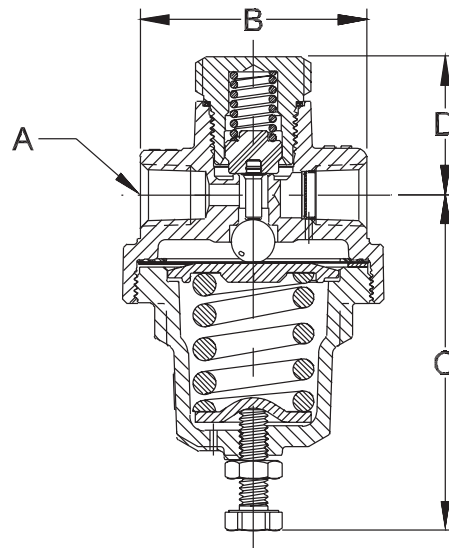

Ordering Information

Part Number	Inlet/Outlet Connections (F/NPT)	"A"	"B"	"C"	"D"	Factory Pressure Setting (psig)	Operating Range (psig)
CBH502-025	1/4"	1/4"	1.97"	2.89"	1.19"	25 psig (1.7 barg)	20-60 psig (1.3-4.1 barg)
CBH502-125						125 psig (8.6 barg)	50-175 psig (3.45-12.1 barg)
CBH502-300						300 psig (20.7 barg)	150-350 psig (10.3-24.1 barg)
CBH502-315						315 psig (21.7 barg)	
CBH502-325						325 psig (22.4 barg)	
CBH502-350						350 psig (24.1 barg)	
CBC502-025						25 psig (1.7 barg)	20-60 psig (1.3-4.1 barg)
CBC502-125						125 psig (8.6 barg)	50-175 psig (3.45-12.1 barg)
CBC502-300						300 psig (20.7 barg)	150-350 psig (10.3-24.1 barg)
CBC502-325						325 psig (22.4 barg)	
CBC502-350	350 psig (24.1 barg)						